



OWNER'S MANUAL

BUILT-IN FRIDGE & FREEZER

Read this owner's manual thoroughly before operating the appliance and keep it handy for reference at all times.

EN ENGLISH IT ITALIANO

SKSFD3604P



MFL70339809
Rev.02_101618

www.signaturekitchensuite.com
Copyright © 2018 Signature Kitchen Suite. All Rights Reserved.

TABLE OF CONTENTS

This manual may contain images or content different from the model you purchased.

This manual is subject to revision by the manufacturer.

- SAFETY INSTRUCTIONS3**
 - IMPORTANT SAFETY INSTRUCTIONS 3
 - Disposal of Your Old Appliance 9

- OPERATION10**
 - Parts and Functions..... 10
 - Dimensions and Clearances..... 11
 - Ambient Temperature 11
 - Notes for Operation 12
 - Using Control Panel..... 13
 - Water Dispenser 14
 - Automatic Icemaker..... 15
 - Suggestion for More Usable Space..... 16
 - Other Functions 16

- SMART FUNCTIONS17**
 - Using SIGNATURE KITCHEN SUITE Application 17
 - Using Smart Diagnosis™ 19

- MAINTENANCE.....20**
 - Notes for Cleaning..... 20
 - Convertible Drawer..... 21
 - Freezer Drawer..... 23
 - Cleaning the Door Bins..... 25
 - Cleaning the Shelves..... 25
 - Vegetable Drawer 26
 - Replacing the Water Filter 27

- TROUBLESHOOTING28**

The following safety guidelines are intended to prevent unforeseen risks or damage from unsafe or incorrect operation of the appliance.

The guidelines are separated into 'WARNING' and 'CAUTION' as described below.

 This symbol is displayed to indicate matters and operations that can cause risk. Read the part with this symbol carefully and follow the instructions in order to avoid risk.

 **WARNING**

This indicates that the failure to follow the instructions can cause serious injury or death.

 **CAUTION**

This indicates that the failure to follow the instructions can cause the minor injury or damage to the product.

IMPORTANT SAFETY INSTRUCTIONS

 **WARNING**

To reduce the risk of explosion, fire, death, electric shock, injury or scalding to persons when using this product, follow basic precautions, including the following:

Children in the Household

- This appliance is not intended for use by persons (including children) with reduced physical, sensory or mental capabilities, or lack of experience and knowledge, unless they have been given supervision or instruction concerning use of the appliance by a person responsible for their safety. Children should be supervised to ensure that they do not play with the appliance.
- If the appliance is equipped with a lock (some models only), keep the key out of reach of children.

For use in Europe:

This appliance can be used by children aged from 8 years and above and persons with reduced physical, sensory or mental capabilities or lack of experience and knowledge if they have been given supervision or instruction concerning use of the appliance in a safe way and understand the hazards involved. Children shall not play with the appliance. Cleaning and user maintenance shall not be made by children without supervision.

Operation

- Do not use the appliance for any purpose (storage of medical or experimental materials or shipping) other than any domestic household food storage use.
- An individual properly grounded branch circuit or circuit breaker must be used in case of requiring disconnect after installation.
- Unplug the power plug during a severe thunderstorm or lightening or when not in use for a long period of time.
- Do not use the appliance for any purpose (storage of medical or experimental materials or shipping) other than any domestic household food storage use.
- Unplug the power plug during a severe thunderstorm or lightening or when not in use for a long period of time.
- Do not touch the power plug or the appliance controls with wet hands.
- Do not bend the power cable excessively or place a heavy object on it.
- If water penetrates electrical parts of the appliance, disconnect power plug and contact an Signature Kitchen Suite customer information centre.
- Do not place hands or metallic objects inside the area emitting the cold air, cover or heat releasing grille on the back.
- Do not apply excessive force or impact to the back cover of the appliance.
- Do not put animals, such as pets into the appliance.

- Be careful of nearby children when you open or close the appliance door. The door may bump the child and cause injury.
- Avoid the danger of children getting trapped inside the appliance. A child trapped inside the appliance can cause suffocation.
- Do not place heavy or fragile objects, containers filled with liquid, combustible substances, flammable objects (such as candles, lamps, etc.), or heating devices (such as stoves, heaters, etc.) on the appliance.
- If there is a gas leakage (isobutane, propane, natural gas, etc.), do not touch the appliance or power plug and ventilate the area immediately. This appliance uses a refrigerant gas (isobutane, R600a). Although it uses a small amount of the gas, it is still combustible gas. Gas leakage during appliance transport, installation or operation can cause fire, explosion or injury if sparks are caused.
- Do not use or store flammable or combustible substances (ether, benzene, alcohol, chemical, LPG, combustible spray, insecticide, air freshener, cosmetics, etc.) near the appliance.
- Immediately unplug the power plug and contact an Signature Kitchen Suite customer information centre if you detect a strange sound, odour, or smoke coming from the appliance.
- Fill with potable water only into icemaker or dispenser water tank.
- Do not damage the refrigerant circuit.
- Do not place any electronic appliance (such as heater and mobile phone) inside the appliance.

Maintenance

- Disconnect the power cord before cleaning the appliance or replacing the inside lamp (where fitted).
- Securely plug the power plug in the socket outlet after completely removing any moisture and dust.
- Never unplug the appliance by pulling on the power cable. Always grip the power plug firmly and pull straight out from the socket outlet.

- Do not spray water or inflammable substances (toothpaste, alcohol, thinner, benzene, flammable liquid, abrasive, etc.) over the interior or exterior of the appliance to clean it.
- Do not clean the appliance with brushes, cloths or sponges with rough surfaces or which are made of metallic material.
- Only qualified service personnel from Signature Kitchen Suite service centre should disassemble, repair, or modify the appliance. Contact an Signature Kitchen Suite customer information centre if you move and install the appliance in a different location.
- Do not use a hair drier to dry the inside of the appliance or place a candle inside to remove the odours.
- Do not use mechanical devices or other means to accelerate the defrosting process.
- Connect the water supply line (for plumbed models only) to a potable water source only. Otherwise, impurities in the water may cause illness.

Disposal

- When discarding the appliance, remove the door gasket while leaving the shelves and baskets in place and keep children away from the appliance.
- Dispose of all packaging materials (such as plastic bags and styrofoam) away from children. The packaging materials can cause suffocation.

Technical Safety

- Keep ventilation openings, in the appliance enclosure or in the built-in structure, clear of obstruction.
- Do not use electrical appliances inside the refrigerator.
- The refrigerant and insulation blowing gas used in the appliance require special disposal procedures. Consult with service agent or a similarly qualified person before disposing of them.

- This appliance contains a small amount of isobutane refrigerant (R600a), but it is also combustible. When transporting and installing the appliance, care should be taken to ensure that no parts of the refrigerating circuit are damaged.
- Refrigerant leaking out of the pipes could ignite or cause an explosion.
- If a leak is detected, avoid any naked flames or potential sources of ignition and air the room in which the appliance is standing for several minutes. In order to avoid the creation of a flammable gas air mixture if a leak in the refrigerating circuit occurs, the size of the room in which the appliance is used should correspond to the amount of refrigerant used. The room must be 1 m² in size for every 8 g of R600a refrigerant inside the appliance.
- The amount of refrigerant in your particular appliance is shown on the identification plate inside the appliance.
- Never start up an appliance showing any signs of damage. If in doubt, consult your dealer.
- This appliance is intended to be used in household and similar applications only. It should not be used for commercial, or catering purposes, or in any mobile application such as a caravan or boat.
- Do not store explosive substances such as aerosol cans with a flammable propellant in this appliance.

CAUTION

To reduce the risk of minor injury to persons, malfunction, or damage to the product or property when using this product, follow basic precautions, including the following:

Installation

- Do not tilt the appliance to pull or push it when transporting.
- Make sure not to get a body part such as a hand or foot stuck while moving the appliance.

Operation

- Do not touch frozen food or the metal parts in the freezer compartment with wet or damp hands. It may cause frostbite.
- Do not place glass containers, bottles or cans (especially those containing carbonated drinks) in the freezer compartment, shelves or ice bin that will be exposed to temperatures below freezing.
- Do not strike or apply excessive force to any glass surface. Do not touch glass surfaces if they are cracked or broken.
- Do not hang from the appliance door, storage room, shelf or fridge door in door or climb up into it.
- Do not store an excessive amount of water bottles or containers for side dishes on the door baskets.
- Prevent animals from nibbling on the power cable or water hose.
- Do not open or close the appliance door with excessive force.
- If the hinge of the appliance door is damaged or operates improperly, stop using the appliance and contact an authorized service centre.
- Do not clean glass shelves or covers with warm water when they are cold. They may break if exposed to sudden temperature changes.
- Never eat frozen foods immediately after they have been taken out in the freezer compartment.
- Do not insert your hands into the mechanical part of the automatic icemaker such as the ice bin or the ice dispenser.
- Do not use a thin crystal cup or chinaware when dispensing.
- Do not remove the cover of the automatic icemaker. Touching any mechanical part of the automatic icemaker. It may result in injury.
- Make sure not to get a hand or foot stuck upon opening or closing the appliance door or door in door.

- Do not open the door of the appliance with the door in door open, or do not open the door in door while the door of the appliance is open. The door in door may be struck by the edge of the appliance and damaged.

Maintenance

- Do not insert the shelves upside down. The shelves may fall.
- To remove frost from the appliance, contact an Signature Kitchen Suite customer information centre.
- Dispose of the ice inside the ice bin in the freezer compartment during an extended power outage.

Disposal of Your Old Appliance



- This crossed-out wheeled bin symbol indicates that waste electrical and electronic products (WEEE) should be disposed of separately from the municipal waste stream.
- Old electrical products can contain hazardous substances so correct disposal of your old appliance will help prevent potential negative consequences for the environment and human health. Your old appliance may contain reusable parts that could be used to repair other products, and other valuable materials that can be recycled to conserve limited resources.
- You can take your appliance either to the shop where you purchased the product, or contact your local government waste office for details of your nearest authorised WEEE collection point. For the most up to date information for your country please see www.lg.com/global/recycling.

Parts and Functions

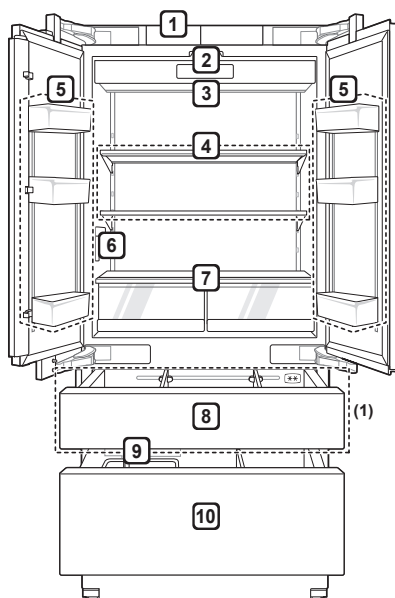

1 Water Filter

Purifies water.

NOTE

The filter should be replaced every 6 months. See the Replacing the Water Filter section in this manual for details.

2 Control Panel

- Sets the appliance temperature and the waterfilter condition.

3 LED Interior Lighting

- Lights up the inside of the fridge.

4 Adjustable Fridge Shelf

- The fridge shelves are adjustable to meet individual storage needs.

NOTE

- The 2-star section () basket or drawer can be used to store ice and food from -12 °C to -18 °C for short periods.
- The upper drawer(1) apply the 2-star section.

5 Movable Door Bin

- Store chilled food or drinks.

6 Water Dispenser

7 Vegetable drawer

8 Convertible Drawer

9 Icemaker

10 Freezer Drawer

Dimensions and Clearances

- Too small of a distance from adjacent items may result in the degradation of freezing capability and increased electricity costs. Allow over 50 mm of clearance from each adjacent wall when installing the appliance.

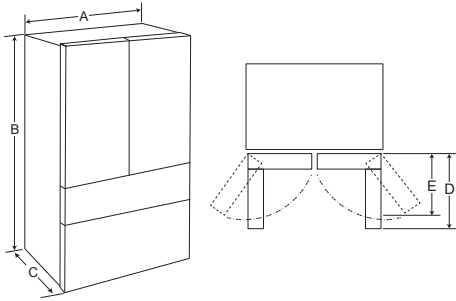

-	Size
A	908 mm
B	2121 mm
C	607 mm
D	556 mm
E	520 mm

Ambient Temperature

- The appliance is designed to operate within a limited range of ambient temperatures, depending on the climate zone. Do not use the appliance at a temperature exceeding the limit.
- The internal temperature could be affected by the location of the appliance, the ambient temperature, the frequency of door opening and so on.
- The climate class can be found on the rating label.

Climate Class	Ambient Temperature Range °C
SN (Extended Temperate)	+10 - +32
N (Temperate)	+16 - +32
ST (Subtropical)	+16 - +38
T (Tropical)	+16 - +43 / +10 - +43*

*Australia, India, Kenya

NOTE

- The appliances rated from SN to T are intended to be used at an ambient temperature between 10 °C and 43 °C.

Notes for Operation

- Do not use the ice water dispenser tank for beverages other than drinking water.
- Users should keep in mind that frost can form. If the door is not closed completely, if the humidity is high during the summer, or if the freezer door is opened frequently.
- Ensure there is sufficient space between food stored on the shelf or door basket to allow the door to close completely.
- Opening the door lets warm air enter the appliance, and may cause the internal temperature to rise.
- Note that a temperature rise after defrosting has a permissible range in the appliance specifications. If you wish to minimise the impact this may have on the food storage due to a temperature rise, seal or wrap the stored food in several layers.

Suggestion for Energy Saving

- Ensure there is sufficient space between stored foods. This allows cold air to be circulated evenly and lowers electricity bills.
- Store hot food only after it has cooled in order to prevent dew or frost.
- When storing food in the freezer compartment, set the freezer temperature lower than the temperature indicated on the appliance.
- Do not set the temperature of the appliance lower than needed. For ice making in normal climates, the freezer temperatures should be set to -18 °C or colder.
- Do not put food near the temperature sensor of the fridge compartment. Keep a distance of at least 3 cm from the sensor.
- The automatic defrosting system in the appliance ensures that the compartment remains free of ice buildup under normal operating conditions.

Storing Foods Effectively

- Store frozen food or refrigerated food inside sealed containers.
- Check the expiration date and label (storage instructions) before storing food in the appliance.
- Do not store food for a long period of time (more than four weeks) if it spoils easily at a low temperature.
- Place the refrigerated food or frozen food in each fridge or freezer compartment immediately after purchasing.
- Avoid refreezing any food which has been completely thawed. Freezing any food which has been completely thawed again will lower its taste and nutrition.
- Do not wrap and store vegetables with newspaper. Printing material of newspaper or other foreign substances may smear and contaminate food.
- Do not overfill the appliance. Cold air can not circulate properly if the appliance is overfilled.
- If you set an excessively low temperature for food, it may become frozen. Do not set a temperature lower than the required temperature for the food to be stored correctly.

Max Freezing Capacity

- The Ice Plus function will allow the freezer to its maximum freezing capacity. This generally takes up to 24 hours, however, it will automatically turn off after a given time and can also be turned off manually at any given time.
- To get better air circulation, insert all inner parts like baskets, drawers, and shelves.

Using Control Panel

Units and Functions

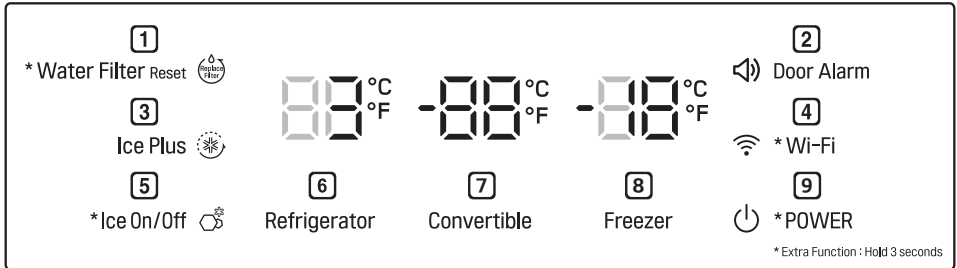

1 Water Filter Reset

- Replace the water filter when the Replace Filter icon turns on. Replace the water filter approximately every six months.

2 Door Alarm

- This sets the alarm sound which is activated when the appliance door is opened.

3 Ice Plus

- This increases both ice making and freezing capabilities.

4 * Wi-Fi

- The Wi-Fi button, when used with the Signature Kitchen Suite smartphone app, allows the appliance to connect to a home Wi-Fi network. Refer to the Smart Functions section for information on the initial setup of the application.

5 * Ice On/Off

- Press the Ice On/Off button for three seconds to turn the icemaker on/off.

6 Refrigerator

- This sets the fridge target temperature.

7 Convertible

- Variable temperature storage that can be set either colder or warmer than the appliance.

8 Freezer

- This sets the freezer target temperature.

9 * Power

- The Power button turns off all electrical power to the unit.

NOTE

- When the appliance is in the Power Saving Mode, the display remains off until a door is opened or a button is pressed. Once on, the display remains on for 20 seconds.
- The control panel will turn off automatically for energy saving.
- If there is any finger or skin contact to the control panel while cleaning it, the button function may operate.

Setting the Temperature

This sets the fridge temperature or freezer temperature.

- Press the **Refrigerator** button or **Freezer** button to adjust the temperature.
- The initial temperature is set.
 - Fridge : 3 °C
 - Freezer : -18 °C
- The temperature can be adjusted.
 - Fridge : from 0 °C to 6 °C
 - Freezer : from -24 °C to -16 °C
- The actual inner temperature varies depending on the food status, as the indicated setting temperature is a target temperature, not actual temperature within the appliance.

NOTE

- The default temperature setting may vary depending on the appliance.
- Wait until two or three hours have passed after connecting the appliance to the outlet before storing food in the appliance.

Convertible

Variable temperature storage that can be set either colder or warmer than the appliance. Store meat and seafood at -1°C, cold drinks at 1°C, deli snacks at 3°C, or chilled wine at 5°C.

To use the convertible drawer as a freezer, select the current freezer temperature. For example, if the freezer is set to -18°C, then -18°C automatically appears in the Convertible display as an option.

Once the convertible drawer is set to freezer mode, its temperature matches the freezer temperature. Changing the freezer temperature automatically changes the drawer temperature. Pressing the Convertible temperature button unlinks the drawer and returns it to refrigeration mode.

Power button

The Power button turns off all electrical power to the unit.

Press and hold the Power button for 3 seconds to turn off the power. When the power is off, the indicator light is off. There is no need to turn off power at the circuit breaker or wall receptacle. Use this function for service or extended vacations.

Setting Ice Plus

This function increases both ice making and freezing capabilities.

- Press the Ice Plus button to illuminate the icon and activate the function for 24 hours. The function automatically shuts off after 24 hours.
- Stop the function manually by pressing the button once more.

Water Dispenser

To dispense water, push on the water paddle with a glass.

CAUTION

- Keep children away from the dispenser. Children may play with or damage the controls.
- If water is dispensed unexpectedly, turn off the water supply and contact a Signature Kitchen Suite Customer Information Center.
- After installation, dispense 9.5 liters of water (flush for approximately 5 minutes) to remove trapped air and contaminants from the system.

NOTE

- Some dripping may occur after dispensing. Hold the cup beneath the dispenser for a few seconds after dispensing to catch all of the drops.

Automatic Icemaker

The automatic icemaker can automatically make 12 cubes at a time, within a 12hr period if conditions are favorable. This amount may vary according to the environment (ambient temperature around the appliance, frequency of the door being opened, amount of food stored in the appliance, etc.).

- If the ice bin is completely filled with ice, ice production will stop.
- Sound of ice dropping into the ice bin is normal.
- To increase ice production, use the Ice Plus function. The function increases both ice making and freezing capabilities.
- Discard ice produced for the first time without using it.
- While the automatic icemaker is operating, do not touch it with your hands directly.
- If ice cubes are stored in the ice bin for a long period of time, they may clump together and may not be separated easily. In such a case, clean the ice bin before using it.

Turning the Automatic Icemaker On or Off

To turn off the automatic Icemaker, press the **ice On/ Off** button on the display for three seconds.

CAUTION

- Throw away the first few batches of ice. This is also necessary if the appliance has not been used for a long time.
- The first ice and water dispensed may include particles or odor from the water supply line or the water tank.
- Keep children away from the dispenser. Children may play with or damage the controls.
- The ice passage may become blocked with frost if only crushed ice is used. Remove the frost that accumulates by removing the ice bin and clearing the passage with a rubber spatula. Dispensing cubed ice periodically can also help prevent frost buildup.
- If discolored ice is dispensed, check the water tank and the water supply for a possible source. If the problem continues, contact the Signature Kitchen Suite customer information centre. Do not use the ice or water until the problem is corrected.
- Dispense ice into a glass before filling it with water or other beverages. Splashing may occur if ice is dispensed into a glass that already contains liquid.
- Do not touch the ice outlet or the automatic icemaker with your hand or a tool. Otherwise, appliance damage or injury may occur.
- When refitting the ice bin, ensure that it is placed correctly. If it is tilted or unlevel, it may not continue to make ice due to sensor disruption.
- Never use a glass that is exceptionally narrow or deep. Ice may jam in the ice passage, affecting the performance of the appliance.
- Keep the glass at a proper distance from the ice outlet. A glass held too close to the outlet may prevent ice from dispensing.
- Dispose of the ice inside the ice bin in the freezer compartment if you go on vacation or if an extended power outage occurs. Water from melting ice may drop from the dispenser onto the floor.

Suggestion for More Usable Space

Using Without Drawer Support

To make more spacious refrigerator compartment, remove drawer supports and shelves.

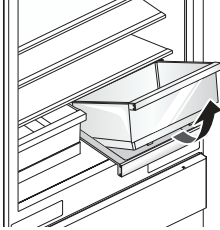

- 1 Press the levers on either side of the drawer support.

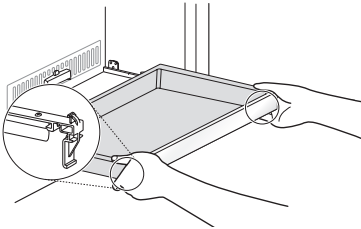

- 2 Keeping both levers pressed, lift the drawer support slightly and remove it from the rail system.

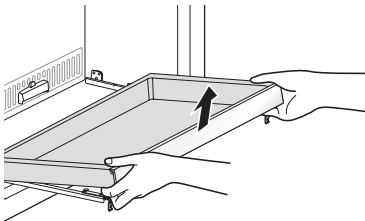

Other Functions

Door Open Alarm

The alarm sounds 3 times in 30 second intervals if the door (fridge compartment, freezer compartment) is left open or not completely closed for one minute.

- Contact the Signature Kitchen Suite customer information centre if the alarm sound continues even after closing the door.

Failure Detection

The appliance can automatically detect problems during the operation.

- If a problem is detected, the appliance may not operate and an error code is displayed even when any button is pressed.
- When this occurs, do not turn off the power and immediately contact the Signature Kitchen Suite customer information centre. If you turn off the power, the repair technician from the Signature Kitchen Suite customer information centre may have difficulty finding the problem.

Using SIGNATURE KITCHEN SUITE Application

- For appliances with the  or  logo

Things to check before using SIGNATURE KITCHEN SUITE

- 1 Check the distance between the appliance and the wireless router (Wi-Fi network).
 - If the distance between the appliance and the wireless router is too far, the signal strength becomes weak. It may take a long time to register or installation may fail.
- 2 Turn off the **Mobile data** or **Cellular Data** on your smartphone.
 - For iPhones, turn data off by going to **Settings** → **Cellular** → **Cellular Data**.

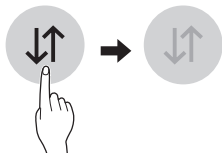

- 3 Connect your smartphone to the wireless router.

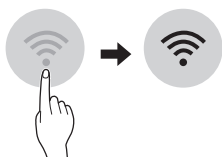

NOTE

- To verify the Wi-Fi connection, check that **Wi-Fi**  icon on the control panel is lit.
- The appliance supports 2.4 GHz Wi-Fi networks only. To check your network frequency, contact your Internet service provider or refer to your wireless router manual.

- SIGNATURE KITCHEN SUITE is not responsible for any network connection problems or any faults, malfunctions, or errors caused by network connection.
- If the appliance is having trouble connecting to the Wi-Fi network, it may be too far from the router. Purchase a Wi-Fi repeater (range extender) to improve the Wi-Fi signal strength.
- The Wi-Fi connection may not connect or may be interrupted because of the home network environment.
- The network connection may not work properly depending on the Internet service provider.
- The surrounding wireless environment can make the wireless network service run slowly.
- The appliance cannot be registered due to problems with the wireless signal transmission. Unplug the appliance and wait about a minute before trying again.
- If the firewall on your wireless router is enabled, disable the firewall or add an exception to it.
- The wireless network name (SSID) should be a combination of English letters and numbers. (Do not use special characters.)
- Smartphone user interface (UI) may vary depending on the mobile operating system (OS) and the manufacturer.
- If the security protocol of the router is set to **WEP**, you may fail to set up the network. Please change it to other security protocols (**WPA2** is recommended) and register the product again.

Installing SIGNATURE KITCHEN SUITE

Search for the SIGNATURE KITCHEN SUITE application from the Google Play Store or Apple App Store on a smart phone. Follow instructions to download and install the application.

Wi-Fi Function

Communicate with the appliance from a smart phone using the convenient smart features.

Firmware Update

Keep the appliance performance updated.

Smart Diagnosis™

If you use the Smart Diagnosis function, you will be provided with the useful information such as a correct way of using the appliance based on the pattern of use.

Settings

Allows you to set various options on the appliance and in the application.

NOTE

- If you change your wireless router, Internet service provider, or password, delete the registered appliance from the Signature Kitchen Suite application and register it again.
- The application is subject to change for appliance improvement purposes without notice to users.
- Functions may vary by model.

Connecting to Wi-Fi

The **Wi-Fi** button, when used with the SIGNATURE KITCHEN SUITE application, allows the appliance to connect to a home Wi-Fi network. The **Wi-Fi** icon shows the status of the appliance's network connection. The icon illuminates when the appliance is connected to the Wi-Fi network.

Initial Appliance Registration

Run the Signature Kitchen Suite application and follow the instructions in the application to register the appliance.

Re-registering the Appliance or Registering Another User

Press and hold the **Wi-Fi** button for 3 seconds to temporarily turn it off. Run the SIGNATURE KITCHEN SUITE application and follow the instructions in the application to register the appliance.

NOTE

- To disable the Wi-Fi function, press and hold the **Wi-Fi** button for 3 seconds. Wi-Fi icon will be turned off.

Wireless LAN Module Specifications

Model	LCW-003
Frequency Range	2412 to 2472 MHz
Output Power(Max)	IEEE 802.11b:18.37 dBm IEEE 802.11g:17.67 dBm IEEE 802.11n:17.67 dBm

Wireless function S/W version : V 1.0

For consideration of the user, this device should be installed and operated with a minimum distance of 20 cm between the device and the body.

Declaration of Conformity



Hereby, LG Electronics declares that the radio equipment type Refrigerator is in compliance with Directive 2014/53/EU. The full text of the EU declaration of conformity is available at the following internet address:

<http://www.lg.com/global/support/cedoc/cedoc#>

LG Electronics European Shared Service Centre B.V.

Krijgsman 1

1186 DM Amstelveen

The Netherlands



Open Source Software Notice Information

To obtain the source code under GPL, LGPL, MPL, and other open source licenses, that is contained in this product, please visit <http://opensource.signaturekitchensuite.com>.

In addition to the source code, all referred license terms, warranty disclaimers and copyright notices are available for download.

Signature Kitchen Suite will also provide open source code to you on CD-ROM for a charge covering the cost of performing such distribution (such as the cost of media, shipping, and handling) upon email request to opensource@signaturekitchensuite.com. This offer is valid for a period of three years after our last shipment of this product. This offer is valid to anyone in receipt of this information.

Using Smart Diagnosis™

- For appliances with the  or  logo

Smart Diagnosis™ Through the Customer Information Centre

Use this function if you need an accurate diagnosis by an Signature Kitchen Suite customer information centre when the appliance malfunctions or fails. Use this function only to contact the service representative, not during normal operation.

- 1 Call the Signature Kitchen Suite Customer Information Center function.

- 2 Open the fridge door.

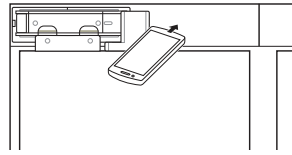

- 3 Press and hold the **Freezer** button for three seconds or longer while continuing to hold your phone to the speaker.
- 4 After the data transfer is complete, the service agent will explain the result of the Smart Diagnosis™.

NOTE

- Position the phone so that its microphone is aligned with the speaker hole.
- The Smart Diagnosis™ sound is generated after pressing the **Freezer** button for three seconds.
- Hold the phone to the upper right speaker hole and wait while the data is transmitted.
- Do not take the phone off the speaker hole while the data is transmitted.
- The data transfer sound may be harsh to the ear while the Smart Diagnosis™ data is being transmitted, but do not take the phone off the speaker hole for accurate diagnosis until the data transfer sound has stopped.
- When the data transfer is complete, the transfer completion message is displayed and the control panel is automatically turned off and then on again after a few seconds. Afterwards the customer information centre explains the diagnosis result.
- The Smart Diagnosis™ function depends on the local call quality.
- The communication performance will improve and you can transmit a better signal if you use a land line home phone.
- If the Smart Diagnosis™ data transfer is poor due to poor call quality, you may not receive the best Smart Diagnosis™ service.

Notes for Cleaning

- When removing a shelf or drawer from inside the appliance, remove all stored foods from the shelf or drawer to prevent injury or damage to the appliance.
 - Otherwise, injury may occur due to the weight of stored foods.
- If cleaning the outside air vents of the appliance by means of vacuuming, then the power cord should be unplugged from the outlet to avoid any static discharge that can damage the electronics or cause an electric shock.
- Detach the shelves and drawers and clean them with water, and then dry them sufficiently, before replacing them.
- Regularly wipe the door gaskets with a wet soft towel.
- Door basket spills and stains should be cleaned as they can compromise storage ability of the basket and could even be damaged.
- After cleaning, check if the power cable is damaged, warm or improperly plugged.
- Keep the air vents on the exterior of the appliance clean.
 - Blocked air vents can cause fire or appliance damage.
- Waxing external painted metal surfaces helps provide rust protection. Do not wax plastic parts. Wax painted metal surfaces at least twice a year using appliance wax (or auto paste wax). Apply wax with a clean, soft cloth.
- When cleaning the inside or outside of the appliance, do not wipe it with a rough brush, toothpaste, or flammable materials. Do not use cleaning agents containing flammable substances.
 - This may cause discoloration or damage to the appliance.
 - Flammable substances: alcohol (ethanol, methanol, isopropyl alcohol, isobutyl alcohol, etc.), thinner, bleach, benzene, flammable liquid, abrasive, etc.

- For the appliance exterior, use a clean sponge or soft cloth and a mild detergent in warm water. Do not use abrasive or harsh cleaners. Dry thoroughly with a soft cloth.
- Never clean the shelves or containers in the dishwasher.
 - The parts may become deformed due to the heat.
- If the appliance is equipped with an LED lamp, do not remove lamp cover and LED lamp in any attempt to repair or service it. Please, contact the Signature Kitchen Suite customer information centre.

Cleaning the Mullion Heater Terminals

Do not use glass cleaners, abrasive cleansers, water, or flammable fluids when cleaning the MullionHeater Terminals (1).

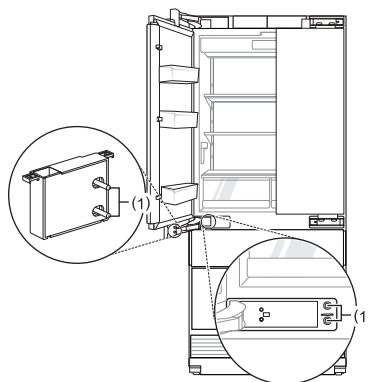

CAUTION

- Use a clean sponge or soft cloth only.

Convertible Drawer

Removing the Convertible Drawer

- 1** Pull the drawer out until it stops. Empty all contents out of the drawer before removing it.

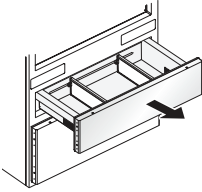

- 2** Push the button and disengage the stopper on either side.

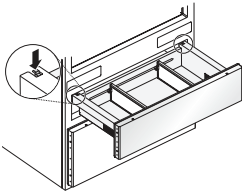

- 3** Remove the basket by lifting the basket from the rail system.

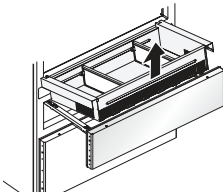

- 4** Remove the screws from the rails at both sides.

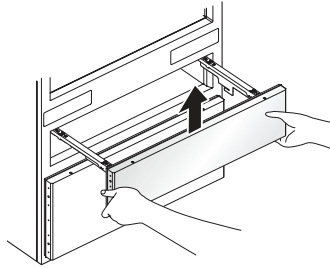

- 5** Hold both sides of the door and lift it to remove it from the rail system.

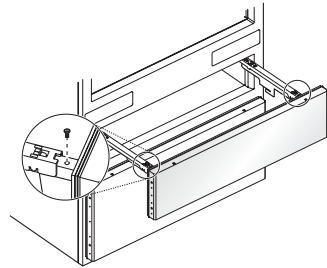

WARNING

- The drawers are heavy. Always use two hands when removing or assembling the drawers to avoid product damage or personal injury. Always empty drawers before removing them.
- Always open the drawer door completely before removing or assembling the drawers.

Assembling the Convertible Drawer

- 1 Grasp the door on each side and lower it into place on the rail system.

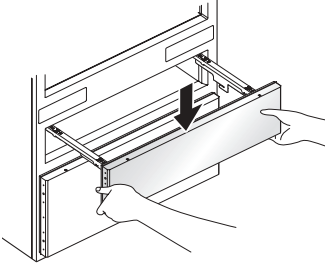

- 2 Insert screws at the end of both rails.

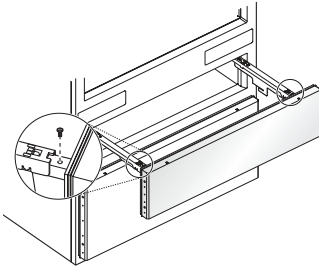

- 3 Pull the drawer open to full extension Lower the basket onto the rail system.

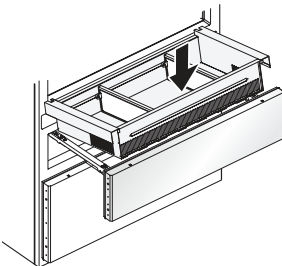

- 4 Push the button and engage the stopper on either side.

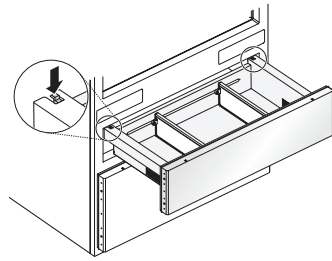

Freezer Drawer

Removing the Freezer Drawer

The convertible drawer must be removed before the freezer drawer can be removed.

- 1 Pull the drawer out until it stops. Empty all contents out of the drawer before removing it.

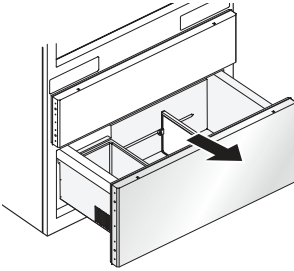

- 2 Push the button and disengage the stopper on either side.

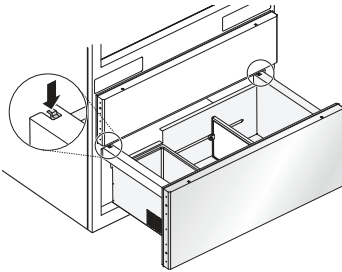

- 3 Remove the basket by lifting the basket from the rail system.

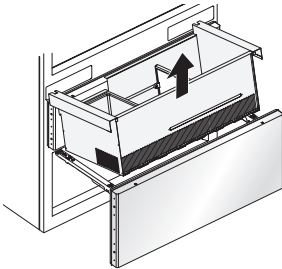

- 4 Remove the screws from the rails at both sides.

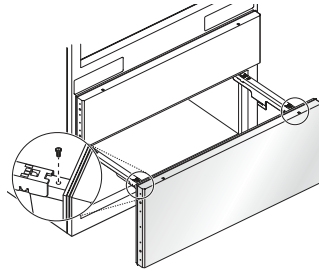

- 5 Hold both sides of the door and lift it to remove it from the rail system.

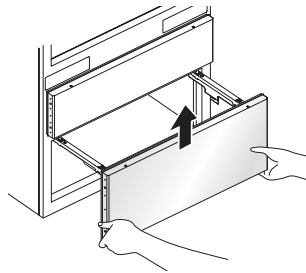

Assembling the Freezer Drawer

The convertible drawer must be removed in order to assemble the freezer drawer.

- 1 Grasp the door on each side and lower it into place on the rail system.

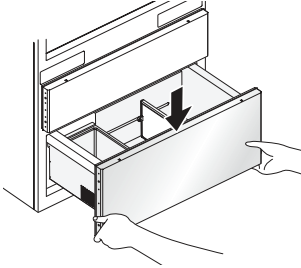

- 2 Insert screws at the end of both rails.

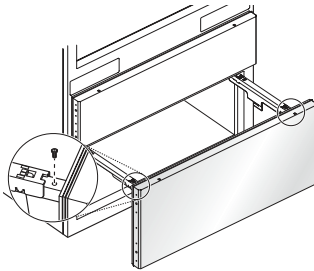

- 3 Pull the drawer open to full extension. Lower the basket onto the rail system.

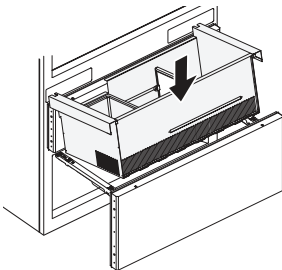

- 4 Push the button and engage the stopper on either side.

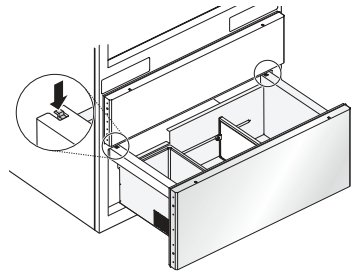

Cleaning the Door Bins

To remove the door bins, hold the bin with both hands and tilt the back edge up.

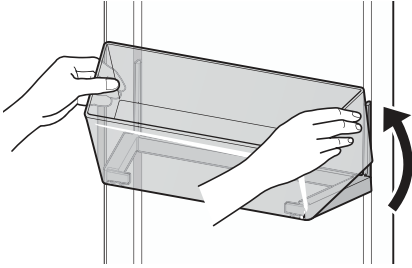

To assemble the door bin, align both sides of the bin with the guides and push the bin down until it snaps into place.

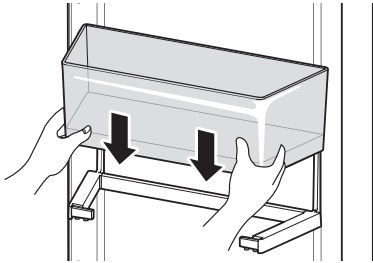

To adjust the location of the bin, tilt the front of the bin up and slide the bin up or down to the desired location.

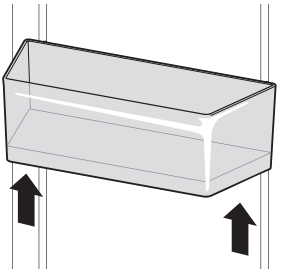

Cleaning the Shelves

The shelves in the appliance are adjustable to meet individual storage needs. Adjusting the shelves to fit items of different heights will make finding the exact item you want easier.

Detaching the Shelf

- 1 Tilt up the front of the shelf and then lift the shelf straight up.
- 2 Pull the shelf out.

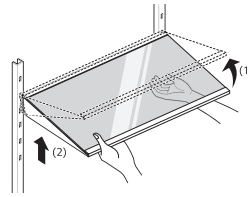

Assembling the Shelf

- 1 Tilt the front of the shelf up and guide the shelf hooks into the slots at a desired height.
- 2 Lower the front of the shelf so that the hooks drop into the slots.

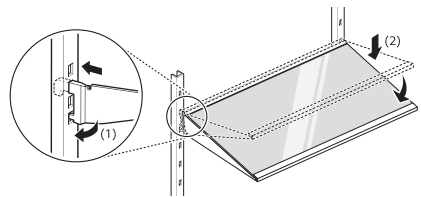

⚠ CAUTION

- Make sure that shelves are level from one side to the other. Failure to do so may result in the shelf falling or spilled food.
- Be careful when removing glass shelves. Glass shelves are heavy.

Vegetable Drawer

Removing the Vegetable Drawer Cover

- Lift up the cover at the front and pull the cover out.

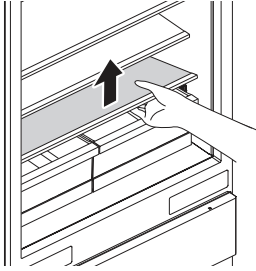

Removing the Vegetable Drawers

- Pull the Vegetable drawer out until it stops.
- Lift the front of the drawer to remove it.

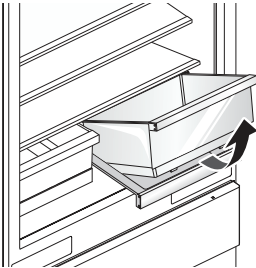

Removing the Vegetable Drawer Frames

- 1 Remove the vegetable drawer.
- 2 Pull the drawer frame out until it stops.
- 3 Press the release levers (1) on either side of the drawer frame and lift the drawer frame.

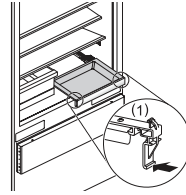

! CAUTION

- Make sure that the vegetable drawer is level from one side to the other. Failure to do so may result in the vegetable drawer falling or spilled food.
- Be careful when removing the vegetable drawer. The vegetable drawer is heavy.

Replacing the Water Filter

Replace the disposable water filter when indicated on the **Replacement Filter** icon or at least every 6 months.

To give you enough time to get a new filter, the light will come on just before the capacity of the current filter runs out. Changing the filter on time ensures that you always get fresh and clean water from the appliance.

- 1 Push to open the water filter cover at the top right of the appliance.

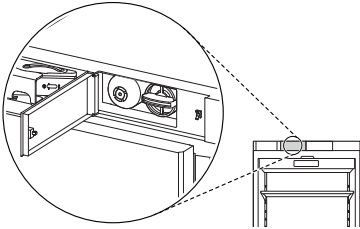

- 2 Remove the old water filter. Put the cap (1) on the water filter, then grasp and rotate it counterclockwise to remove the water filter from the filter head.

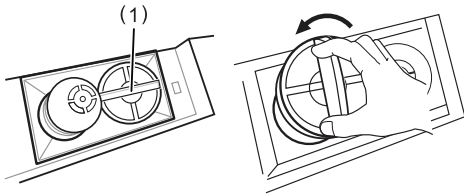

- 3 Replace with a new water filter. Take the new water filter out of its packing and remove the protective cover from the o-rings. Put the cap on the new water filter, then push it into the manifold hole until it stops.

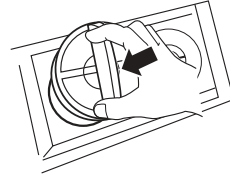

- 4 Grasp and rotate cap clockwise until it stops. Replace the cap to the side of the water filter.

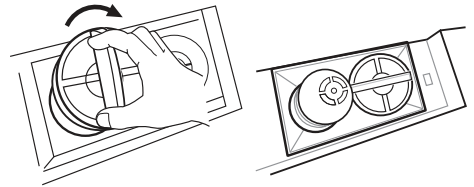

- 5 Dispense 9.5 liters of water (flush for approximately 5 minutes) to remove trapped air and contaminants from the system.

NOTE

- Do not dispense the entire 9.5 liter amount continuously. Press and release the dispenser pad for cycles of 30 seconds ON and 60 seconds OFF.

Symptoms	Reason	Solution
There is no refrigeration or freezing.	Is there a power interruption?	<ul style="list-style-type: none"> • Check the power of other appliances.
	If the power plug unplugged from the outlet?	<ul style="list-style-type: none"> • Plug the power plug in the outlet properly.
There is poor refrigeration or freezing.	Is the fridge or freezer temperature set to its warmest setting?	<ul style="list-style-type: none"> • Set the fridge or freezer temperature to 'Medium'.
	Is the appliance in direct sunlight, or is it near a heat generating object such as cooking oven or heater?	<ul style="list-style-type: none"> • Check the installation area and reinstall it away from heat generating objects.
	Did you store hot food without cooling it first?	<ul style="list-style-type: none"> • Cool the hot food first before putting it in the fridge or freezer compartment.
	Did you put in too much food?	<ul style="list-style-type: none"> • Maintain an appropriate space between food.
	Are the appliance doors completely closed?	<ul style="list-style-type: none"> • Completely close the door and make sure that stored food is not obstructing in the door.
	Is there enough space around the appliance?	<ul style="list-style-type: none"> • Adjust the installation position to make enough space around the appliance.
The appliance contains a bad smell.	Is the fridge or freezer temperature set to 'Warm'?	<ul style="list-style-type: none"> • Set the fridge or freezer temperature to 'Medium'.
	Did you put in food with a strong smell?	<ul style="list-style-type: none"> • Store foods with strong smells in a sealed containers.
	Vegetables or fruit may have spoiled in the drawer?	<ul style="list-style-type: none"> • Throw away rotten vegetables and clean the vegetable drawer. Do not store vegetables too long in the vegetable drawer.
The inside lamp in the appliance does not turn on.	Does the inside lamp in the appliance turn off?	<ul style="list-style-type: none"> • It is not possible for customers to replace the inside lamp in the appliance as they are not serviceable. If the inside lamp does not turn on, please contact the Signature Kitchen Suite customer information centre.

Symptoms	Reason	Solution
The appliance door is not closed tightly.	Is the appliance leaning forward?	<ul style="list-style-type: none"> Adjust the front feet to raise the front side slightly.
	Were the shelves properly assembled?	<ul style="list-style-type: none"> Refit the shelves if needed.
	Did you close the door with excessive force?	<ul style="list-style-type: none"> If you apply too much force or speed when closing the door, it may remain briefly open before closing. Make sure that you do not slam the door closed. Close without force.
It is difficult to open the appliance door.	Did you open the door right after you closed it?	<ul style="list-style-type: none"> If you try to open the appliance door within one minute after you closed it, you may have difficulties because of the pressure inside the appliance. Try to open the appliance door again in a few minutes so that the internal pressure stabilizes.
Door mullion does not fold in and out properly.	Are front leveling legs extended, appliance level, and doors aligned?	<ul style="list-style-type: none"> Once the door baskets are filled, the doors may become misaligned, preventing the door mullion or the Auto Open Door function from working properly. Extend both front leveling legs fully so they are in firm contact with the floor. Follow the instruction in the Door Alignment section to raise the left appliance door until the door mullion is once again working properly. Adjust the right appliance door so it aligns with the left appliance door.
There is condensation inside the appliance or on the bottom of the vegetable drawer cover.	Did you store hot food without cooling it first?	<ul style="list-style-type: none"> Cool the hot food first before putting it in the fridge or freezer compartment.
	Did you leave the appliance door open?	<ul style="list-style-type: none"> Although the condensation will disappear soon after you close the appliance door, you can wipe it with a dry cloth.
	Do you open and close the appliance door too frequently?	<ul style="list-style-type: none"> Condensation can form due to the temperature difference from the outside. Wipe out the dampness with a dry cloth.
	Did you put warm or moist food inside without sealing it in a container?	<ul style="list-style-type: none"> Store food in a covered or sealed container.

Symptoms	Reason	Solution
Frost has formed in the freezer compartment.	Doors may not be closed properly?	<ul style="list-style-type: none"> Check if the food item inside the appliance is blocking the door and make sure that the door is tightly closed.
	Did you store hot food without cooling it first?	<ul style="list-style-type: none"> Cool the hot food first before putting it in the fridge or freezer compartment.
	Is the air entry or exit of the freezer compartment blocked?	<ul style="list-style-type: none"> Make sure that air entry or exit is not blocked so that the air can circulate inside.
	Is the freezer compartment overfilled?	<ul style="list-style-type: none"> Maintain an appropriate space between items.
Frost or condensation has formed inside or outside the appliance.	Did you open and close the appliance door frequently or is the appliance door improperly closed?	<ul style="list-style-type: none"> Frost or condensation can form if the outside air penetrates inside the appliance.
	Is the installation environment humid?	<ul style="list-style-type: none"> Condensation can appear on the exterior of the appliance if the installation area is too humid or on a humid day such as a rainy day. Wipe off any moisture with a dry cloth.
The appliance is noisy and generates abnormal sounds.	Is the appliance installed on a weak floor or improperly leveled?	<ul style="list-style-type: none"> Install the appliance on a solid and flat area.
	Does the rear of the appliance touch the wall?	<ul style="list-style-type: none"> Adjust the installation position to allow enough clearance around the appliance.
	Are objects scattered behind the appliance?	<ul style="list-style-type: none"> Remove the scattered objects from behind the appliance.
	Is there an object on top of the appliance?	<ul style="list-style-type: none"> Remove the object on top of the appliance.
The side or front of the appliance is warm.	There are anti condensation pipes fitted to these areas of the appliance to reduce condensation forming from around the door area.	<ul style="list-style-type: none"> The heat releasing pipe to prevent condensation is installed on the front and side of the appliance. You may feel it particularly hot right after the appliance is installed or during the summer. You can be assured that this is not a problem and is quite normal.
There is water inside or outside of the appliance.	Is there water leakage around the appliance?	<ul style="list-style-type: none"> Check if the water has leaked from a sink or another place.
	Is there water on the bottom of the appliance?	<ul style="list-style-type: none"> Check if the water is from the thawed frozen food or a broken or dropped container.

Symptoms	Reason	Solution
The automatic icemaker does not produce ice or produces a small amount of ice.	Did you install the appliance recently?	<ul style="list-style-type: none"> The ice maker produces ice normally when approximately 48 hours have passed after the appliance is installed.
	Did you connect the water supply pipe to the appliance and open the supply valve?	<ul style="list-style-type: none"> Connect the water supply pipe to the appliance and open the supply valve completely.
	Is the water supply hose bent?	<ul style="list-style-type: none"> If the water supply hose is bent, the water flow could be compromised.
	Have you dispensed a large amount of ice recently?	<ul style="list-style-type: none"> It takes approximately 24 hours to produce more ice in the automatic icemaker. Please wait.
	Did you set the ice maker switch or the automatic icemaker button on the control panel to ON?	<ul style="list-style-type: none"> Press I on the automatic icemaker switch or set ON for the automatic icemaker button on the control panel. (For more details on how to use, visit Signature Kitchen Suite website or use your smart device.)
	Is the temperature of the freezer compartment set too high?	<ul style="list-style-type: none"> If the set temperature is too warm, ice will be produced slowly or not at all. Set the Freezer temperature to -18 °C for normal operation of the automatic icemaker.
	Have you been opening the appliance door frequently?	<ul style="list-style-type: none"> If you open the appliance door frequently, cold air will escape, lowering the speed of ice production. Do not open and close the appliance door frequently.
	Is the appliance door completely closed?	<ul style="list-style-type: none"> If the appliance door is not completely closed, the temperature of the freezer compartment will increase, slowing down the ice production speed. Close the appliance door completely.
Ice is not dispensed.	Is there ice in the ice bin?	<ul style="list-style-type: none"> Check whether there is ice in the ice bin.
	Is the ice clumped in the ice bin?	<ul style="list-style-type: none"> Separate the ice bin and shake it. Discard the remaining clumped ice after shaking the ice bin.

Symptoms	Reason	Solution
Ice is not dispensed.	Unable to hear the sound of ice coming out?	<ul style="list-style-type: none"> In the control panel, select the modes for cubed ice and crushed ice alternately to dispense the ice.
	Is the ice path blocked? (You can check the ice passage by separating the ice bin.)	<ul style="list-style-type: none"> Ice may not be dispensed properly if the ice passage is blocked. Check the ice and clean the ice path regularly.
Water does not come out.	The supply valve may be turned off? (For Plumbed models Only)	<ul style="list-style-type: none"> Open the water supply valve.
	The water dispenser tank may be empty? (Non plumbed models only)	<ul style="list-style-type: none"> Fill the water dispenser tank.
	Is the water supply valve closed? (For Plumbed models Only)	<ul style="list-style-type: none"> Open the water supply valve.
	Are you using unfiltered water?	<ul style="list-style-type: none"> Unfiltered water can contain a large amount of various heavy metals or foreign substances, so the filter may be clogged in the early stage regardless of the life of the filter.
Water tastes strange.	Is the taste of water different when comparing it with the taste of water from the previous water purifier?	<ul style="list-style-type: none"> Has the purified water or cold water not been used for an extended period of time?
	Has it been a long time since you installed and replaced the filter?	<ul style="list-style-type: none"> If an expired filter is used, the purification performance may decline. It is recommended to replace the filter according to the filter replacement period.
	Have you flushed out the filter properly in the initial stage after installing it?	<ul style="list-style-type: none"> When you install or replace the filter for the first time, you need to remove air and activated carbon residue from inside the filter. Use the appliance after dispensing and discharging approximately 5 litres of purified water from the dispenser by pressing the water dispensing lever. (Activated carbon is harmless to humans.)
	Has the purified water or cold water not been used for an extended period of time?	<ul style="list-style-type: none"> The taste of old water may change due to bacterial growth. Use the product after dispensing and discharging approximately 5 litres (approximately three minutes) from the water dispenser.

Symptoms	Reason	Solution
Clicking noises	The defrost control will click when the automatic defrost cycle begins and ends. The thermostat control (or appliance control on some models) will also click when cycling on and off.	<ul style="list-style-type: none"> • Normal Operation
Rattling noises	Rattling noises may come from the flow of appliance, the water line on the back of the unit (for plumbed models only), or items stored on top of or around the appliance.	<ul style="list-style-type: none"> • Normal Operation
	Appliance is not resting evenly on the floor.	<ul style="list-style-type: none"> • Floor is weak or uneven or leveling legs need to be adjusted. See the Door Alignment section.
	Appliance with linear compressor was moved while operating.	<ul style="list-style-type: none"> • Normal operation. If the compressor does not stop rattling after three minutes, turn the power to the appliance off and then on again.
Whooshing noises	Evaporator fan motor is circulating air through the fridge and freezer compartments.	<ul style="list-style-type: none"> • Normal Operation
	Air is being forced over the condenser by the condenser fan.	<ul style="list-style-type: none"> • Normal Operation
Gurgling noises	Appliance flowing through the cooling system	<ul style="list-style-type: none"> • Normal Operation
Popping noises	Contraction and expansion of the inside walls due to changes in temperature.	<ul style="list-style-type: none"> • Normal Operation
Vibrating	If the side or back of the appliance is touching a cabinet or wall, some of the normal vibrations may make an audible sound.	<ul style="list-style-type: none"> • To eliminate the noise, make sure that the sides and back do not make any contact with any wall or cabinet.

Symptoms	Reason	Solution
<p>Your home appliance and smartphone is not connected to the Wi-Fi network.</p>	<p>The password for the Wi-Fi that you are trying to connect to is incorrect.</p>	<ul style="list-style-type: none"> • Find the Wi-Fi network connected to your smartphone and remove it, then register your appliance on SIGNATURE KITCHEN SUITE.
	<p>Mobile data for your smartphone is turned on.</p>	<ul style="list-style-type: none"> • Turn off the Mobile data of your smartphone and register the appliance using the Wi-Fi network.
	<p>The wireless network name (SSID) is set incorrectly.</p>	<ul style="list-style-type: none"> • The wireless network name (SSID) should be a combination of English letters and numbers. (Do not use special characters.)
	<p>The router frequency is not 2.4 GHz.</p>	<ul style="list-style-type: none"> • Only a 2.4 GHz router frequency is supported. Set the wireless router to 2.4 GHz and connect the appliance to the wireless router. To check the router frequency, check with your Internet service provider or the router manufacturer.
	<p>The distance between the appliance and the router is too far.</p>	<ul style="list-style-type: none"> • If the distance between the appliance and the router is too far, the signal may be weak and the connection may not be configured correctly. Move the location of the router so that it is closer to the appliance.